

Kapitel 5c

Berechnung von Invarianten für diskrete Objekte

Invariants for Discrete Structures – An Extension of Haar Integrals over Transformation Groups to Dirac Delta Functions

Hans Burkhardt ¹, Marco Reisert ¹, and Hongdong Li ²

¹University of Freiburg, Computer Science Department, Germany

²National ICT Australia (NICTA), Australian National University,
Canberra ACT, Australia

<http://lmb.informatik.uni-freiburg.de/>

Summary

1. Introduction
2. Invariants for continuous objects
3. Invariants for discrete objects
 - Invariants for polygons
 - 3D-meshes
 - Discrimination performance and completeness
4. Experiments: Object classification in a Tangram database
5. Conclusions

Introduction

- Increased interest in 3D models and 3D sensors induce a growing need to support e.g. the automatic search in such databases
- As the description of 3D objects is not canonical
→ use invariants for their description

Invariant integration over Euclidean group

For (cyclic) image translation and rotation:

$$(g\mathbf{X})[i, j] = \mathbf{X}[k, l]$$

$$\begin{pmatrix} k \\ l \end{pmatrix} = \begin{pmatrix} \cos \varphi & \sin \varphi \\ -\sin \varphi & \cos \varphi \end{pmatrix} \begin{pmatrix} i \\ j \end{pmatrix} - \begin{pmatrix} t_0 \\ t_1 \end{pmatrix}$$

all indices to be understood modulo the image dimensions.

$$A[f](\mathbf{X}) = \frac{1}{2\pi NM} \int_{t_0=0}^N \int_{t_1=0}^M \int_{\varphi=0}^{2\pi} f(g\mathbf{X}) d\varphi dt_1 dt_0$$

Use as kernel functions monomials of pixels of local support and integrate over the Euclidean motion:

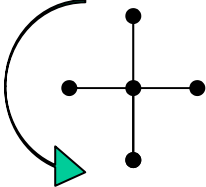

$$f(\mathbf{X}) = m_{00}^3 m_{01}^1 m_{0-1}^5 m_{10}^2 m_{-10}^3$$

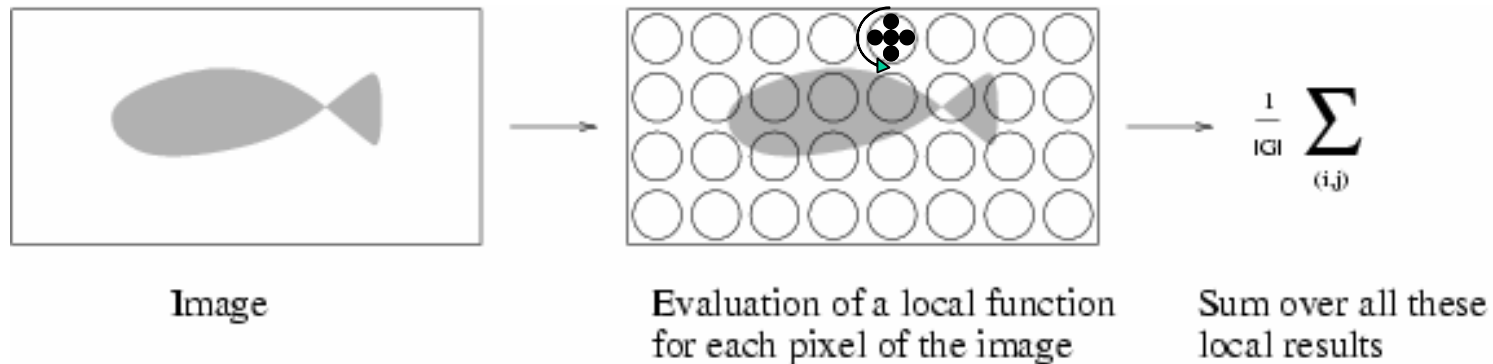

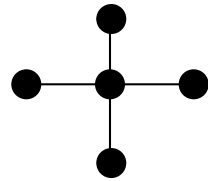

Monomial

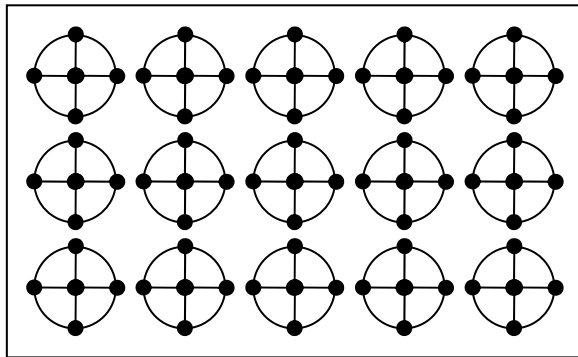

Deterministic integral
over the planar
Euclidean motion

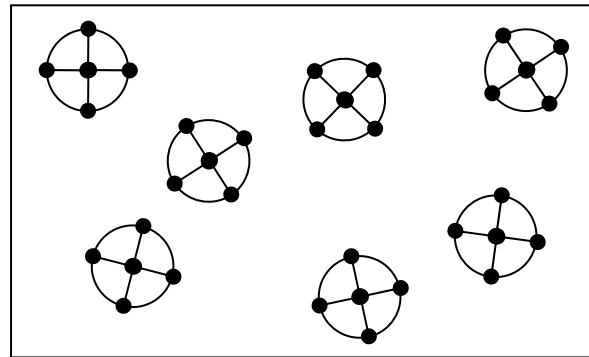

Monte-Carlo-Integration

Pollen examples

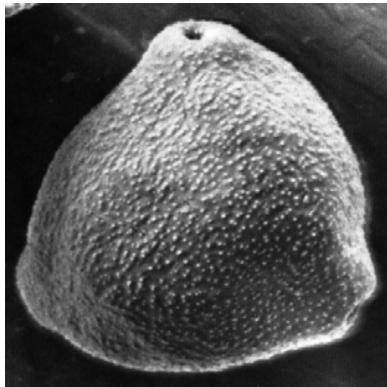

Hasel

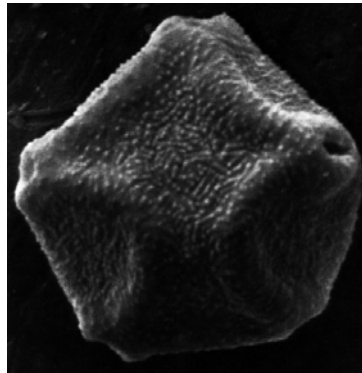

Erle

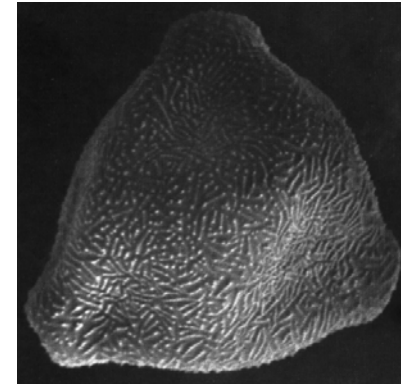

Birke

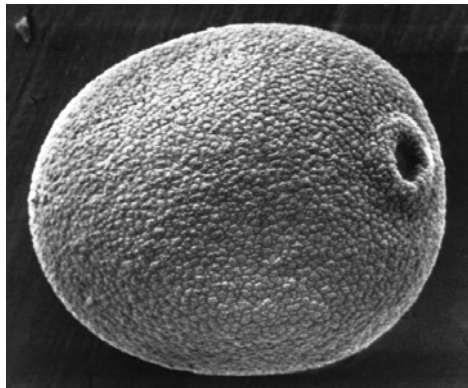

Gräser

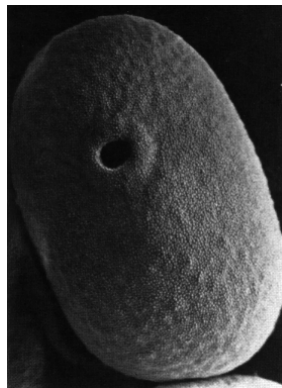

Roggen

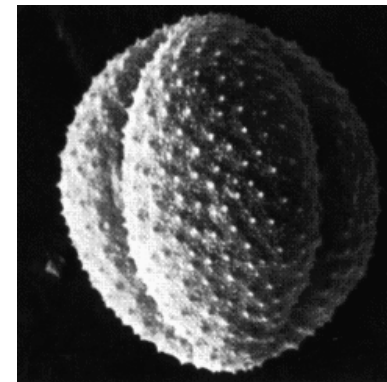

Beifuß

+ 33 further species (not relevant for allergies)

Gänseblümchen/daisy pollen grain

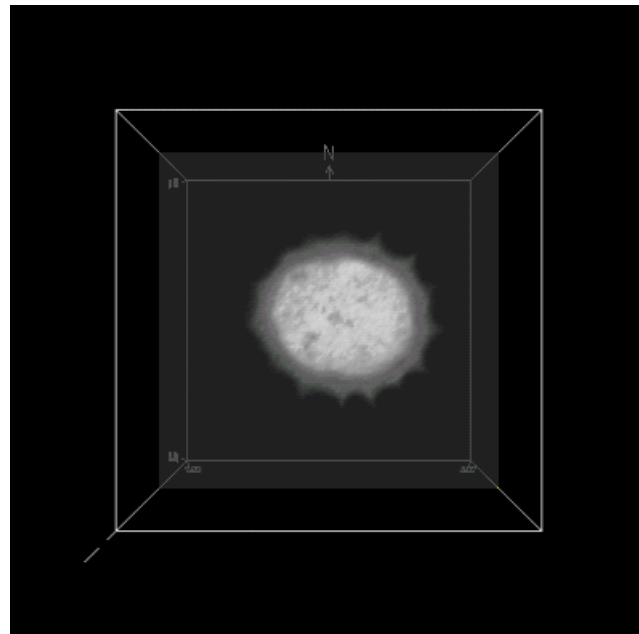

Eibe/Taxus

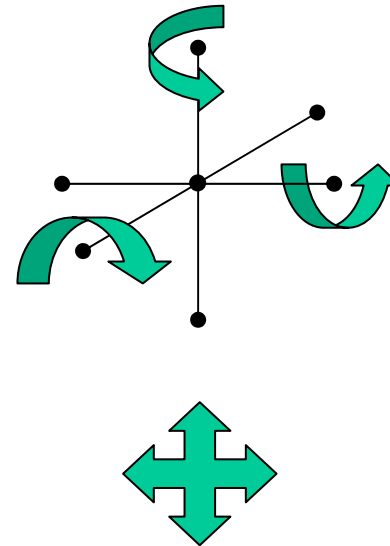
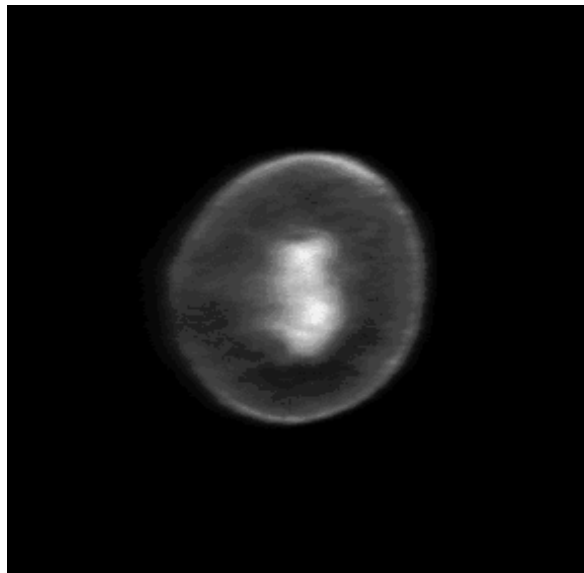

Integrate over Euclidean Motion

Classification Results using 3D LSM Data

(leave-one-out Classification)

	Correct	Wrong classifications
<i>Artemisia:</i>	13	1 -> <i>Compositae</i> , 1 -> <i>Platanus</i>
<i>Alnus:</i>	15	-
<i>Alnus viridis:</i>	12	-
<i>Betula:</i>	13	2 -> <i>Plantago</i>
<i>Corylus:</i>	13	1 -> <i>Alnus</i>
<i>Gramineae/Poaceae:</i>	15	-
<i>Secale:</i>	11	3 -> <i>Fagus</i> , 1 -> <i>Tilia</i>
Allergolocial irrelevant*:	282	2 -> <i>Gramineae</i>
Total:	97.4%	2.6%

* *Acer*, *Carpinus*, *Chenopodium*, *Compositae*, *Cruciferae*, *Fagus*, *Quercus*, *Aesculus*, *Juglans*, *Fraxinus*, *Plantago*, *Platanus*, *Rumex*, *Populus*, *Salix*, *Taxus*, *Tilia*, *Ulmus*, *Urtica*

The Five Platonic Solids

Octahedron

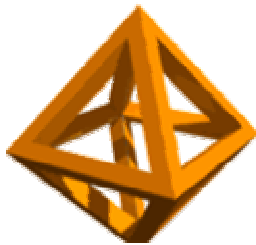

Icosahedron.gif

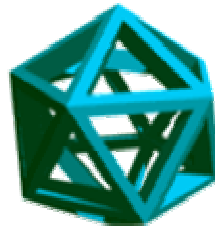

Dodecahedron

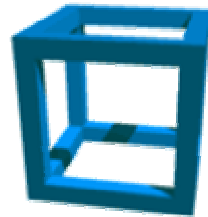

Hexahedron

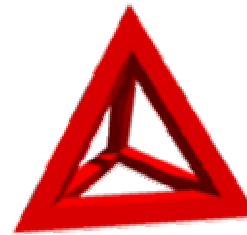

Tetrahedron

A platonic solid is a polyhedron (Polyeder) all of whose faces are congruent regular polygons, and where the same number of faces meet at every vertex. The best know example is a *cube* (or *hexahedron*) whose faces are six congruent squares.

Extension of Haar-Integrals to Discrete Structures

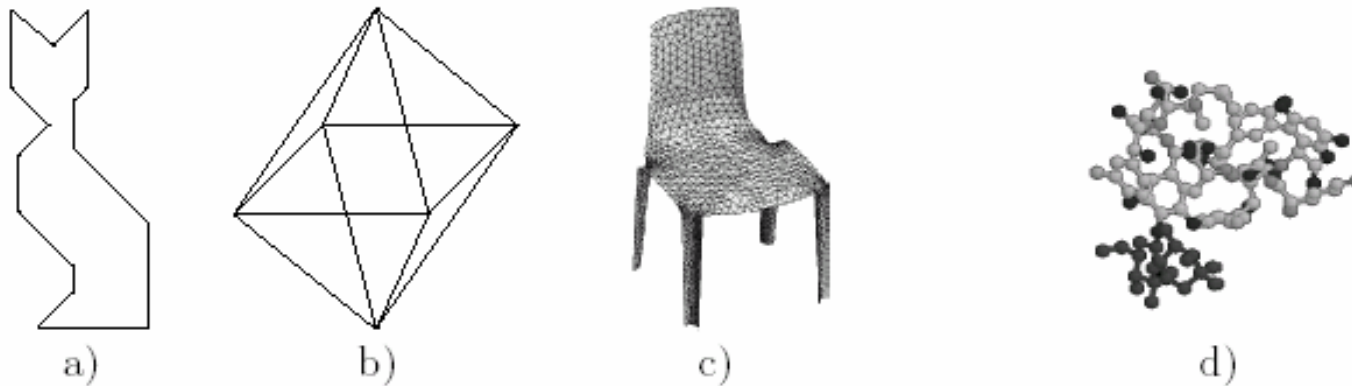

Fig. 1. Discrete structures in 2D and 3D: (a) closed contour described by a polygon (b) wireframe object (c) 3D triangulated surface mesh (d) molecule.

Describe discrete structures with Dirac delta functions!

Invariants on discrete Structures

(topologically equivalent structures)

Chose proper kernel functions on distributions

$$T[f](\mathbf{X}) = \int_G f(g\mathbf{X}) dg$$

1. Chose kernel functions which are different from zero only at the vertices and which act only on neighborhoods of degree m .
2. As each vertex can be visited in an arbitrary permutation of all points by a continuous Euclidean motion the integral is changed into a invariant sum over all vertices with Euclidean-invariant local discrete features !!
3. Use principle of rigidity to reach completeness: use a basis of features which are locally rigid and which can be pieced together in a unique way to the global object (see invariants for triangle!).

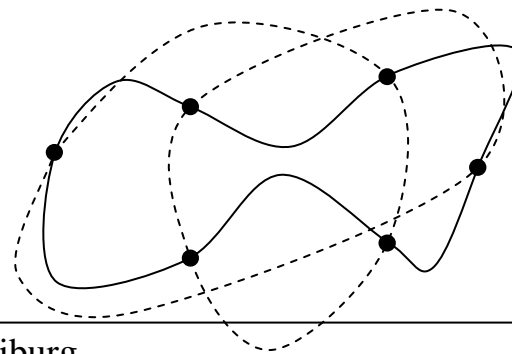

Invariants for discrete objects

1. For a discrete object Δ and a kernel function $f(\Delta)$ it is possible to construct an invariant feature $T[f](\Delta)$ by integrating $f(g\Delta)$ over the transformation group $g \in G$.
2. The kernel function is properly designed, such that it delivers a value dependent on the discrete features of a local neighborhood, when a vertex of the object moved by the continuous Euclidean motion g hits the origin and has one specific orientation.
3. Let us assume that our discrete object is different from zero only at its vertices. A rotation and translation invariant local discrete kernel function h takes care for the algebraic relations to the neighboring vertices and we can write:

$$f(\Delta) = \sum_{i \in \mathbb{V}} h(\Delta, \mathbf{x}_i) \delta(\mathbf{x} - \mathbf{x}_i)$$

where \mathbb{V} is the set of vertices and \mathbf{x}_i the vector representing vertex i .

4. In order to get finite values from the distributions it is necessary to introduce under the Haar integral another integration over the spatial domain \mathbf{X} .
5. By choosing an arbitrary integration path in the continuous group G we can visit each vertex in an arbitrary order the integral is transformed into a sum over all local discrete functions allowing all possible permutations of the contributions of the vertices.

Extension of Haar-Integrals to Discrete Structures

$$\begin{aligned} T[f](\Delta) &:= \int_G \int_{\mathbf{X}} f(g\Delta) d\mathbf{x} dg = \int_G \left[\int_{\mathbf{X}} \sum_{i \in \mathbb{V}} h(g\Delta, g\mathbf{x}_i) \delta(g\mathbf{x} - g\mathbf{x}_i) d\mathbf{x} \right] dg \\ &= \int_G \left[\sum_{i \in \mathbb{V}} h(\Delta, \mathbf{x}_i) \right] dg = \sum_{i \in \mathbb{V}} h(\Delta, \mathbf{x}_i) \end{aligned}$$

Intuitive result: get *global* Euclidean invariants by summation over discrete *local* Euclidean invariants $h(\Delta, \mathbf{x}_i)$!

Remember: The delta function has the following selection property:

$$\int_{-\infty}^{+\infty} f(x) \delta(x - a) dx = f(a)$$

Euclidean Invariants for Polygons

We assume e.g. to have given a polygon with 10 vertices, e.g.

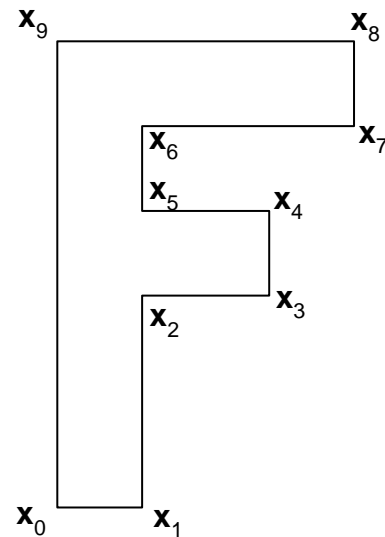

$$\{\mathbf{x}_i\} = \begin{bmatrix} 0 & 1 & 1 & 2.5 & 2.5 & 1 & 1 & 3.5 & 3.5 & 0 \\ 0 & 0 & 2.5 & 2.5 & 3.5 & 3.5 & 4.5 & 4.5 & 5.5 & 5.5 \end{bmatrix}$$

Choose as local Euclidean invariants distances of vertex i and its k -th righthand neighbours:

$$d_{i,k} = \|\mathbf{x}_i - \mathbf{x}_{\langle i+k \rangle}\|$$

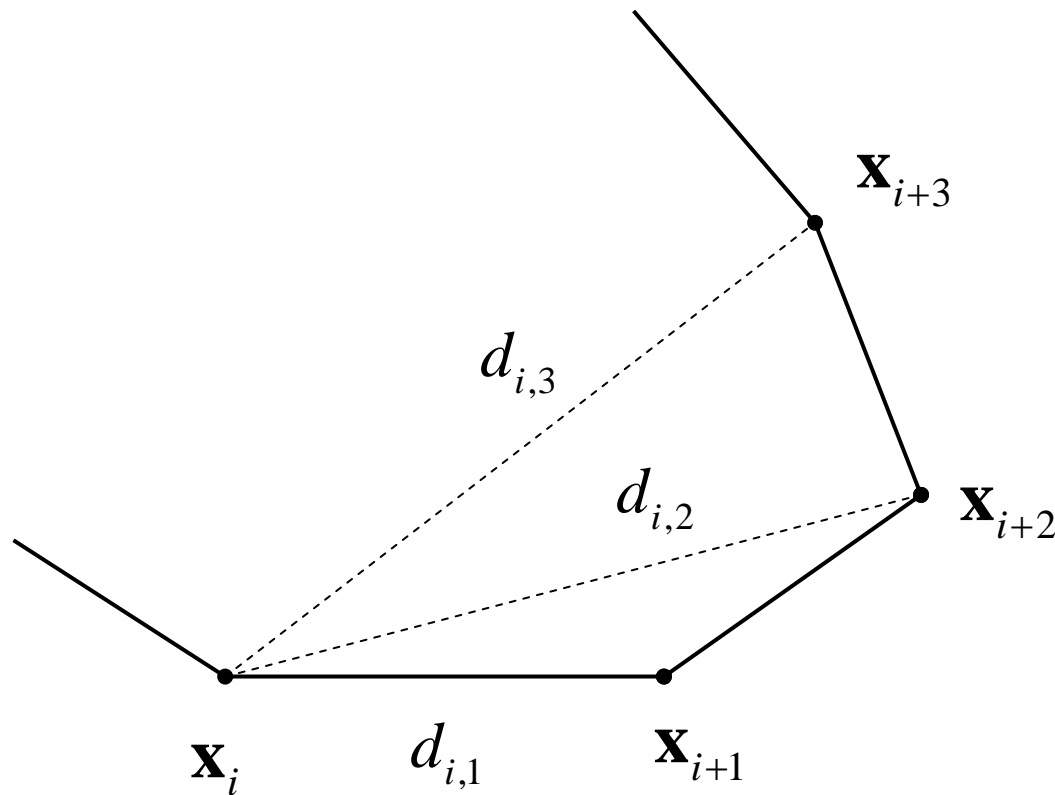

The elements:

$$\{d_{i,1}, d_{i,2}, d_{i,3}\}$$

form a basis for a polygon, because they uniquely define a polygon (up to a mirror-polygon) !

Principle of rigidity

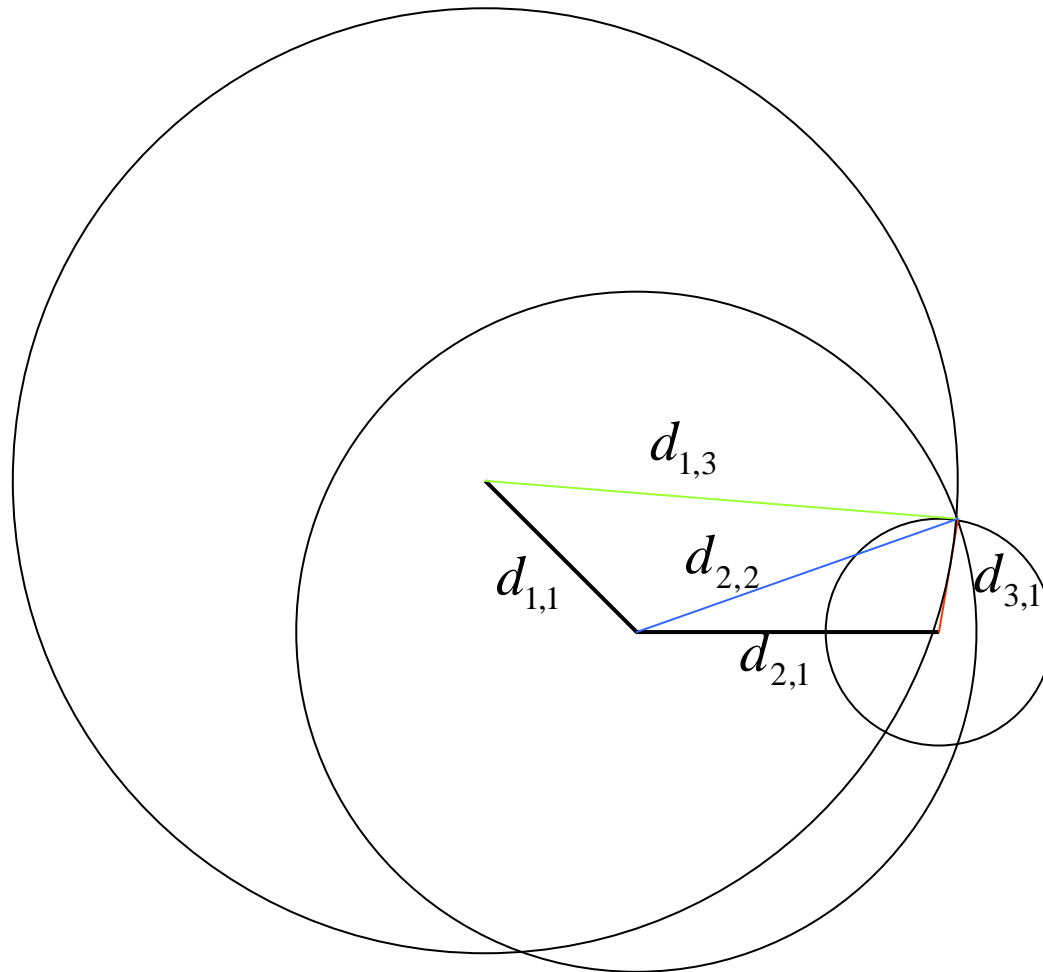

— $d_{i,3}$

— $d_{i,2}$

— $d_{i,1}$

Given two edges $d_{1,1}$ and $d_{2,1}$. Then the third vertex is uniquely defined by the set:

$$\{d_{i,1}, d_{i,2}, d_{i,3}\}$$

Because there is a unique intersection point of three circles.

This means, that a whole polygon can be uniquely generated by this basis elements iteratively.

With the first two distances we get two initial configurations. Then all further vertices will be unique.

The two initial configurations give two possible polygons, where one is just the mirror image of the other along the first edge as its axis.

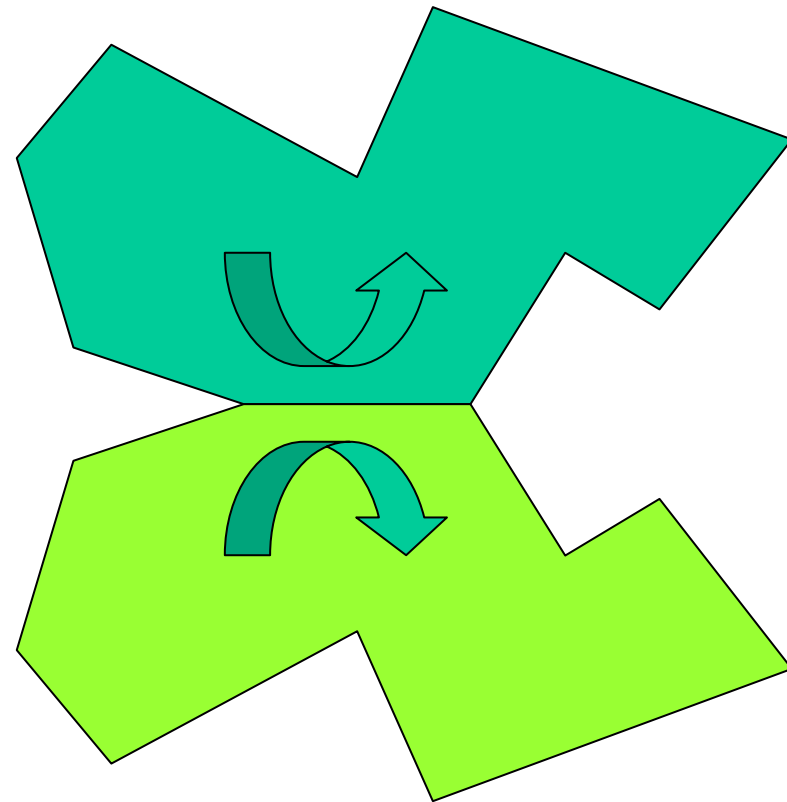
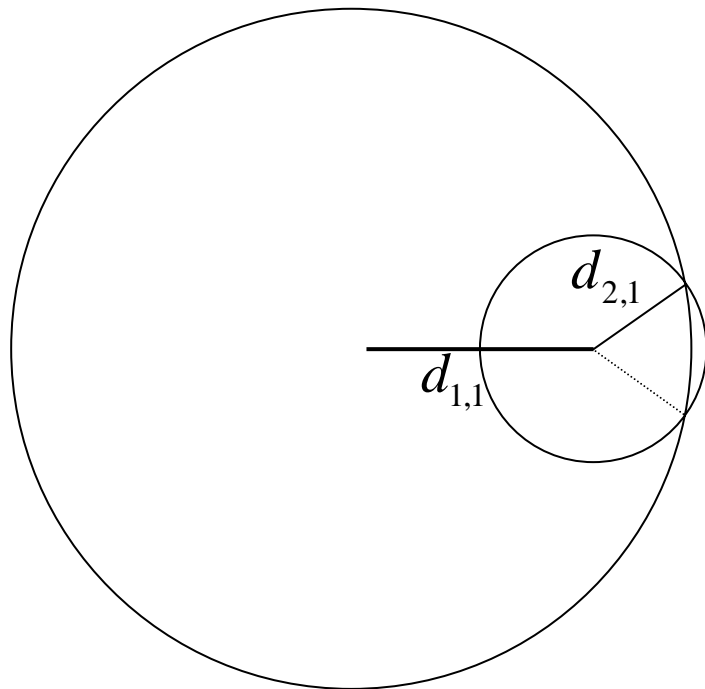

As discrete functions of local support we derive *monomials* from distances between neighbouring vertices and hence we get invariants by summing these discrete functions of local support (DFLS) over all vertices:

$$\tilde{x}_{n_1, n_2, n_3, n_4} = \sum_{i \in \mathbb{V}} h(\Delta, \mathbf{x}_i) = \sum_{i \in \mathbb{V}} d_{i,1}^{n_1} d_{i,2}^{n_2} d_{i,3}^{n_3} d_{i,4}^{n_4}$$

Choosing the following 8 values for the exponents we would end up with a corresponding invariant feature vector and a set of 8 invariants:

i	n_1	n_2	n_3
\tilde{x}_0	1	0	0
\tilde{x}_1	1	1	0
\tilde{x}_2	1	0	1
\tilde{x}_3	1	1	1
\tilde{x}_4	2	0	0
\tilde{x}_5	2	1	0
\tilde{x}_6	2	0	1
\tilde{x}_7	2	1	1

We clearly recognize e.g. \tilde{x}_0

as the circumference of the polygon as an invariant.

For the above example of the letter F we get the following invariants:

$$\tilde{\mathbf{x}} = [21 \quad 44 \quad 83.82 \quad 68.6 \quad 184.6 \quad 665.3 \quad 149.5 \quad 751.6]^T$$

How complete is this set of invariants?

Discrimination Performance, question of completeness

We expect a more and more complete feature space by summing over an increasing number of monomials of this basis elements

Looking at a triangle as the most simplest polygon one can show that the following three features derived from the three sides $\{a,b,c\}$ form a complete set of invariants:

$$\tilde{x}_0 = a + b + c, \quad \tilde{x}_1 = a^2 + b^2 + c^2, \quad \tilde{x}_2 = a^3 + b^3 + c^3$$

These features are equivalent to the elementary symmetrical polynomials in 3 variables which are a complete set of invariants with respect to all permutations.

Completeness for finite Groups

(Emmy Noether, 1916)

For finite Groups G with $|G|$ elements and patterns of dimensionality N the group averages over all monomials of degree $\leq |G|$ are complete and form a basis of the pattern space. The number of monomials is given by

$$\binom{N + |G|}{N}$$

Experiment: Object classification in a Tangram database

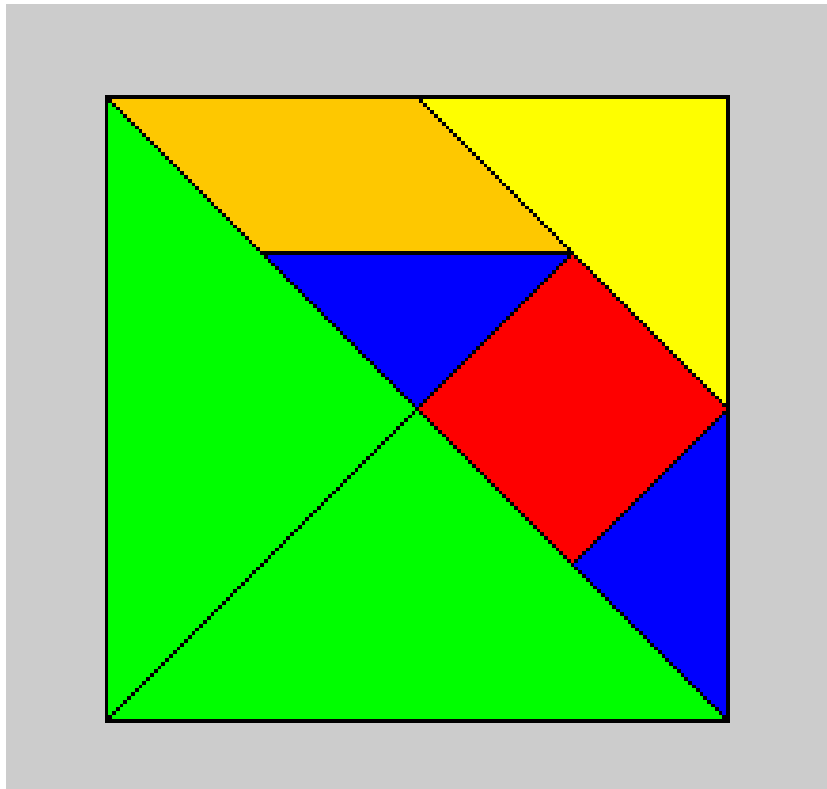

Take the outer contour as feature

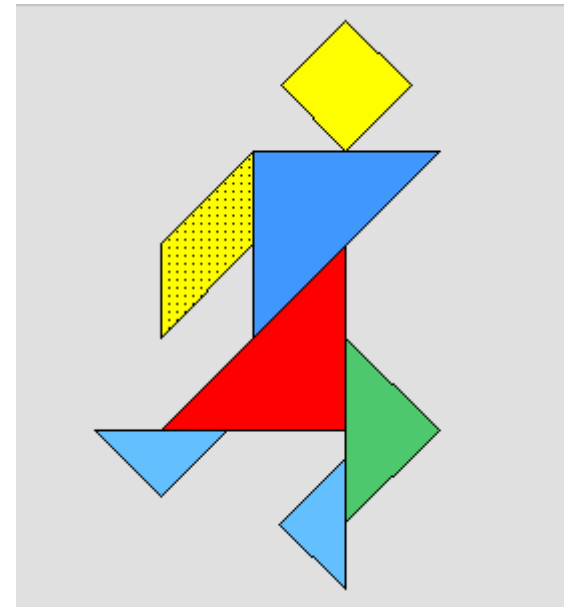

Objects can not easily
be discriminated with
trivial geometric
features!

Cats

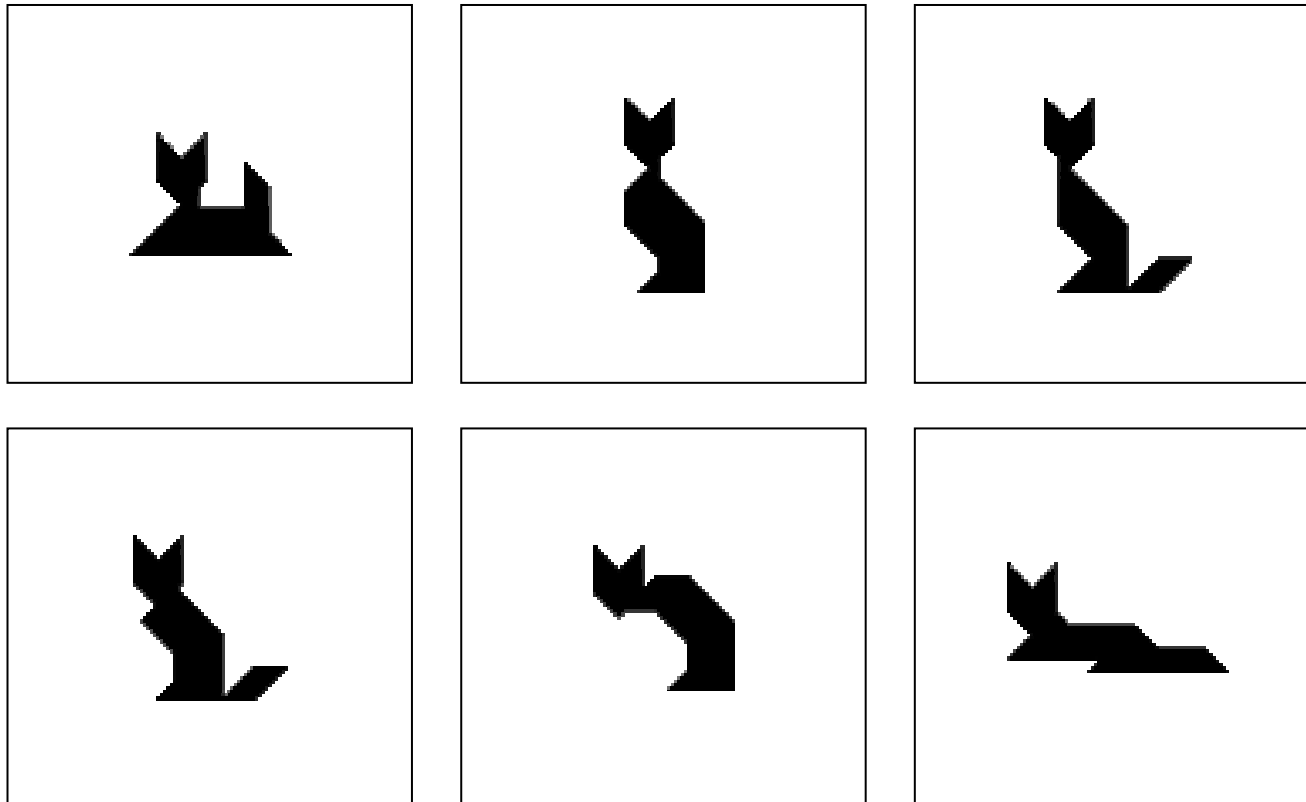

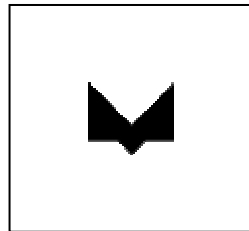

bat.png
n1029923508

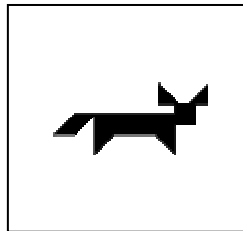

cow.png
n1029410674

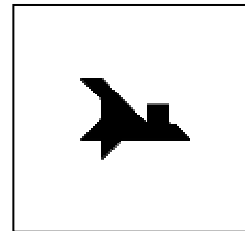

seal.png
n1033206320

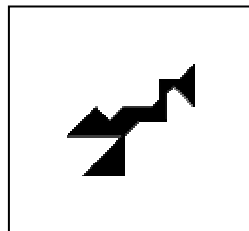

crab1.png
n1029696706

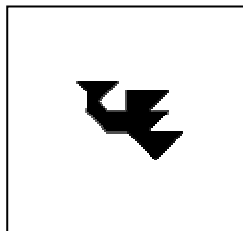

crab2.png
n1029696603

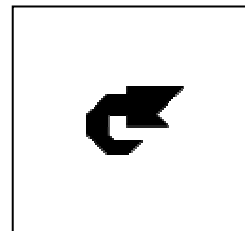

crab3.png
n1029696531

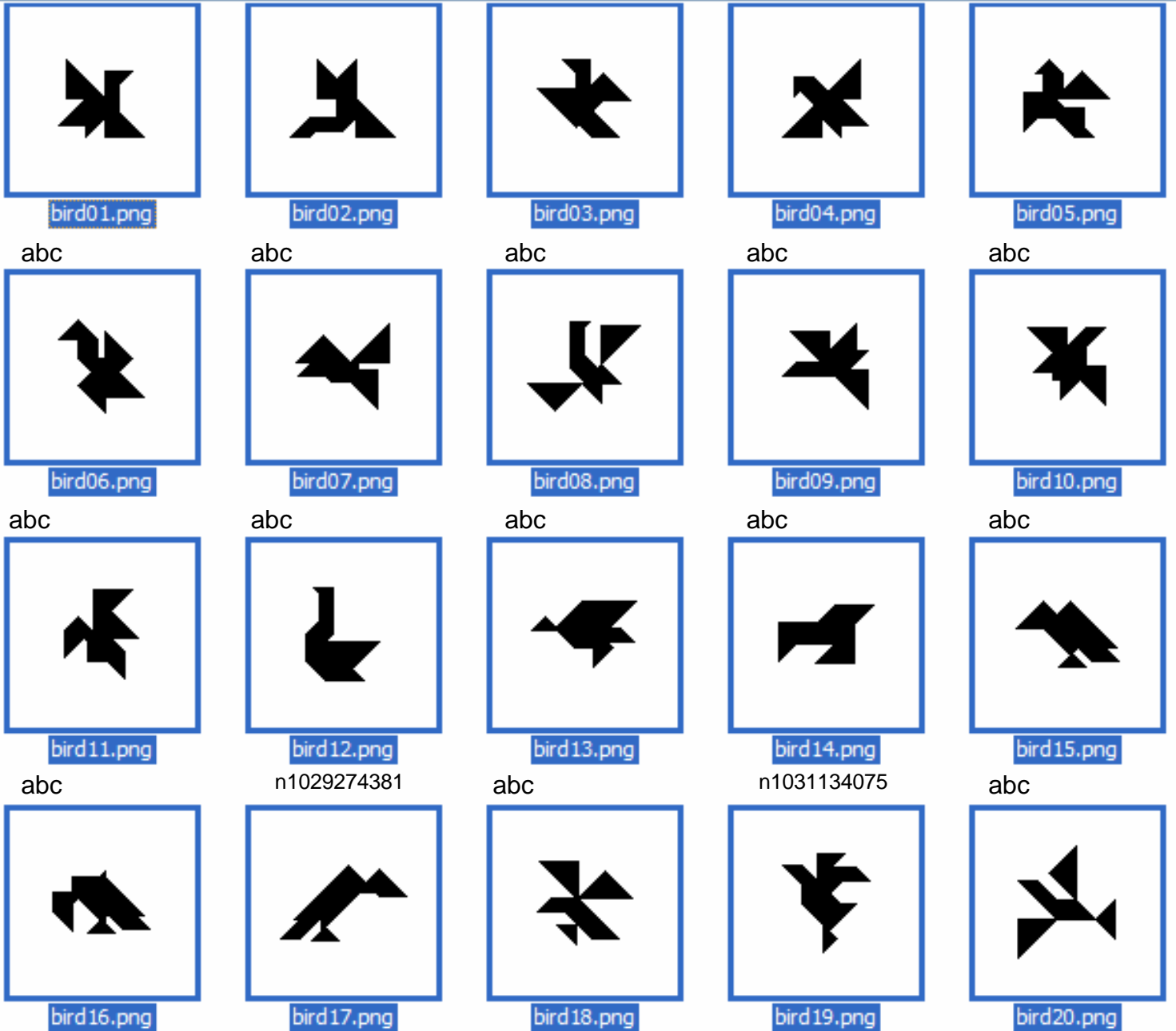



bird21.png

n1029274303



bird22.png

n1029274076



bird23.png

n1029274221



bird24.png

n1029273873



bird25.png

n1029257517



bird26.png

n1029257609

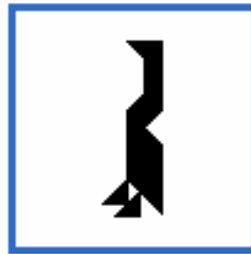

bird27.png

n1029273740



bird28.png

n1029257014



bird29.png

n1029273642

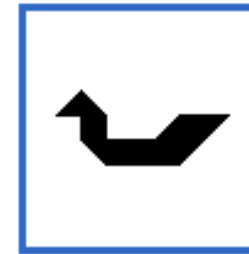

bird30.png

n1029273957



bird31.png

n1029256353



bird32.png

n1029247568



bird33.png

n1029248013



bird34.png

n1029256623

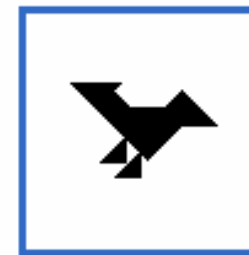

bird35.png

n1029256825



bird36.png

n1029256508



bird37.png

n1029256719



bird38.png

n1029256550

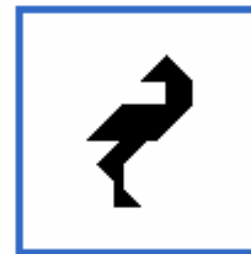

bird39.png

n1029247693

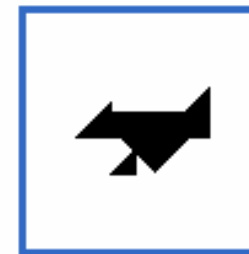

bird40.png

n1029256450

n1030059490



cat1.png

n1029271362



cat2.png

n1029271289

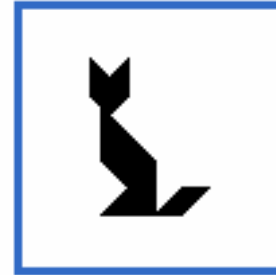

cat3.png



cat4.png



cat5.png

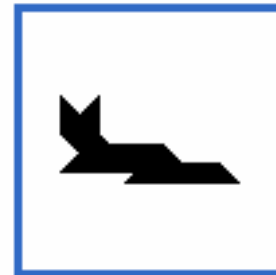

cat6.png

n1029271232

n1029271177

n1029271100

n1029679376

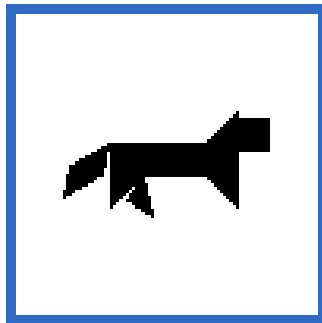

dog1.png

n1029679294

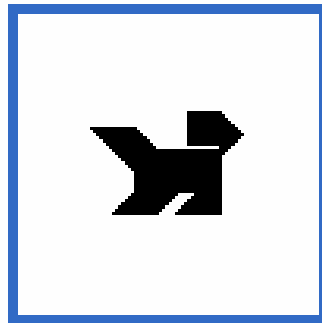

dog2.png

n1029679234

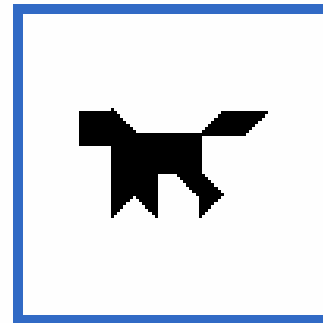

dog3.png

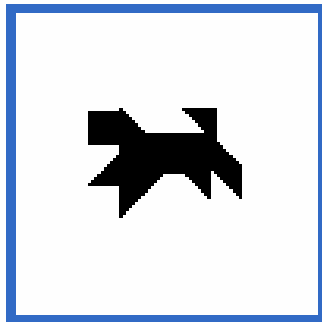

dog4.png

n1029679142

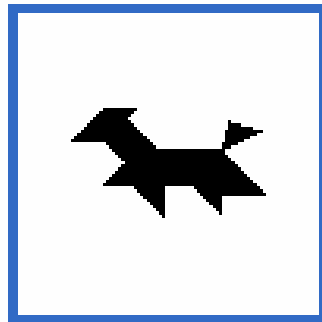

dog5.png

n1029679056

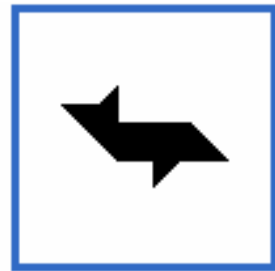

fish01.png

n1029698383

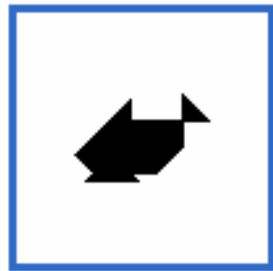

fish02.png

n1029697938

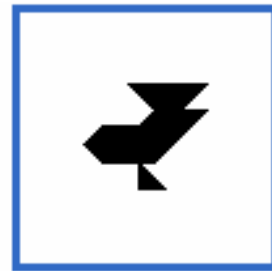

fish03.png

n1029698015

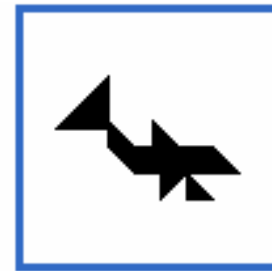

fish04.png

n1029698468



fish05.png

n1029697659

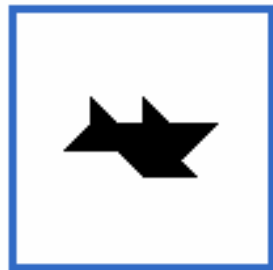

fish06.png

n1029698270



fish07.png

n1029697733



fish08.png

n1029698189

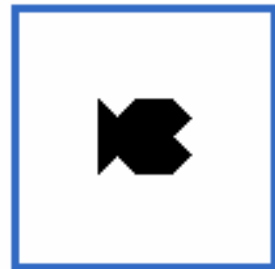

fish09.png

n1029924996

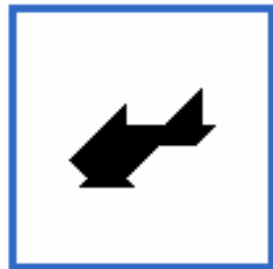

fish10.png

n1029698080



fish11.png

n1029697529

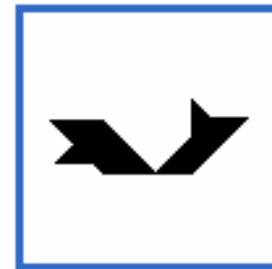

fish12.png

n1029696327



horse01.png

n1029673849



horse02.png

n1029412951

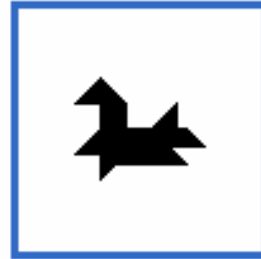

horse03.png

n1029673301

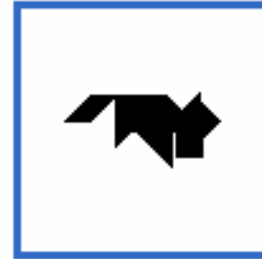

horse04.png

n1029673699



horse05.png

n1029410571



horse06.png

n1029673233



horse07.png

n1029413836



horse08.png

n1029414596



horse09.png

n1029673607

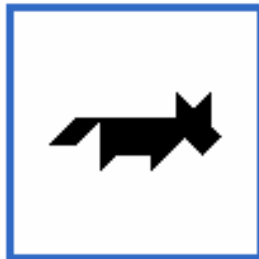

horse10.png

n1029673466

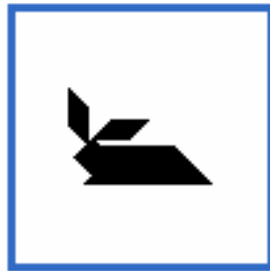

rabbit1.png

n1029281087



rabbit2.png

n1029013797



rabbit3.png

n1029280188



rabbit4.png

n1029280344



rabbit5.png

n1029280468



rabbit6.png

n1029280610



rabbit7.png

n1029280728



snake 1.png

n1029696405



snake 2.png

n1029696963

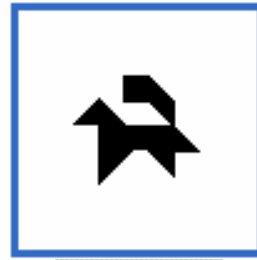

squirrel 1.png

n1029678741

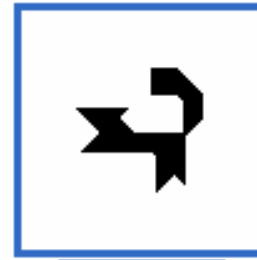

squirrel 2.png

n1029678885

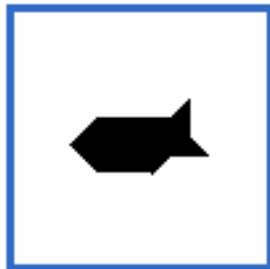

whale 1.png

n1029698609



whale 2.png

n1029697597

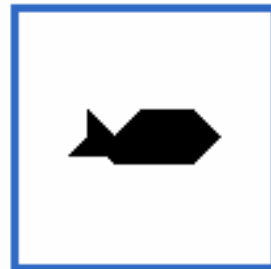

whale 3.png

n1029697454



whale 4.png

n1029696811

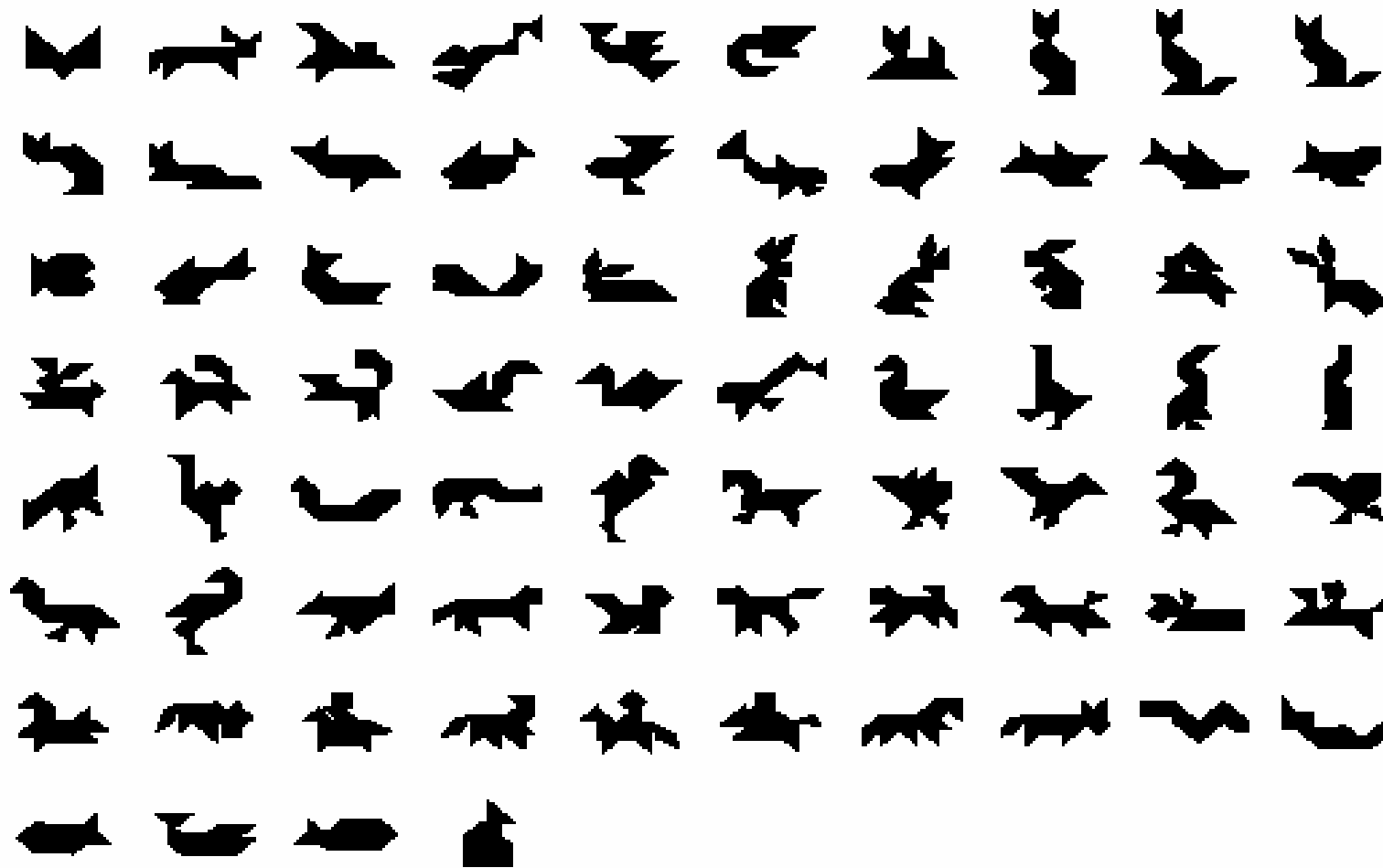

Fig. 6. The 74 tangrams used in the experiment.

The experiments were conducted with three sets of 6, 10 and 14 invariants respectively using the following exponent table:

i	\tilde{x}_0	\tilde{x}_1	\tilde{x}_2	\tilde{x}_3	\tilde{x}_4	\tilde{x}_5	\tilde{x}_6	\tilde{x}_7	\tilde{x}_8	\tilde{x}_9	\tilde{x}_{10}	\tilde{x}_{11}	\tilde{x}_{12}	\tilde{x}_{13}
n_1	1	0	0	1	1	0	0	1	0	0	2	0	0	0
n_2	0	1	0	1	0	1	0	0	1	0	0	2	0	0
n_3	0	0	1	0	1	1	0	0	0	1	0	0	2	0
n_4	0	0	0	0	0	0	1	1	1	1	0	0	0	2

$$\tilde{x}_{n_1, n_2, n_3, n_4} = \sum_{i \in \mathbb{V}} h(\Delta, \mathbf{x}_i) = \sum_{i \in \mathbb{V}} d_{i,1}^{n_1} d_{i,2}^{n_2} d_{i,3}^{n_3} d_{i,4}^{n_4}$$

The classification performance was measured against additive noise of 5%, 10% and 20%.

10% Noise

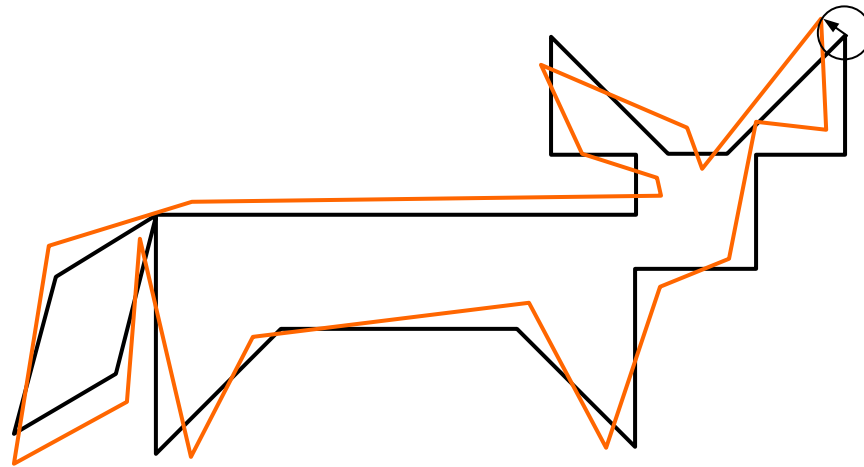

Classification error (in percent) for 5%, 10% and 20% noise for 74 tangrams with a Euclidean (E) and a Mahalanobis (M) Classifier

noise (in percent)	# of invariants	metric	DHI's class. Error in %	FD	F
5	6	E	30	9	0.5
5	10	E	10	7	0.2
5	14	E	6	7	0
10	6	M	1.5	36	14
10	10	M	0	28	6
10	14	M	0	28	5
20	6	M	25	75	59
20	10	M	7	70	50
20	14	M	3	70	46

Empirical evaluation for the degree of completeness!

CI. Error for 5% Noise, Euclidean-CI.

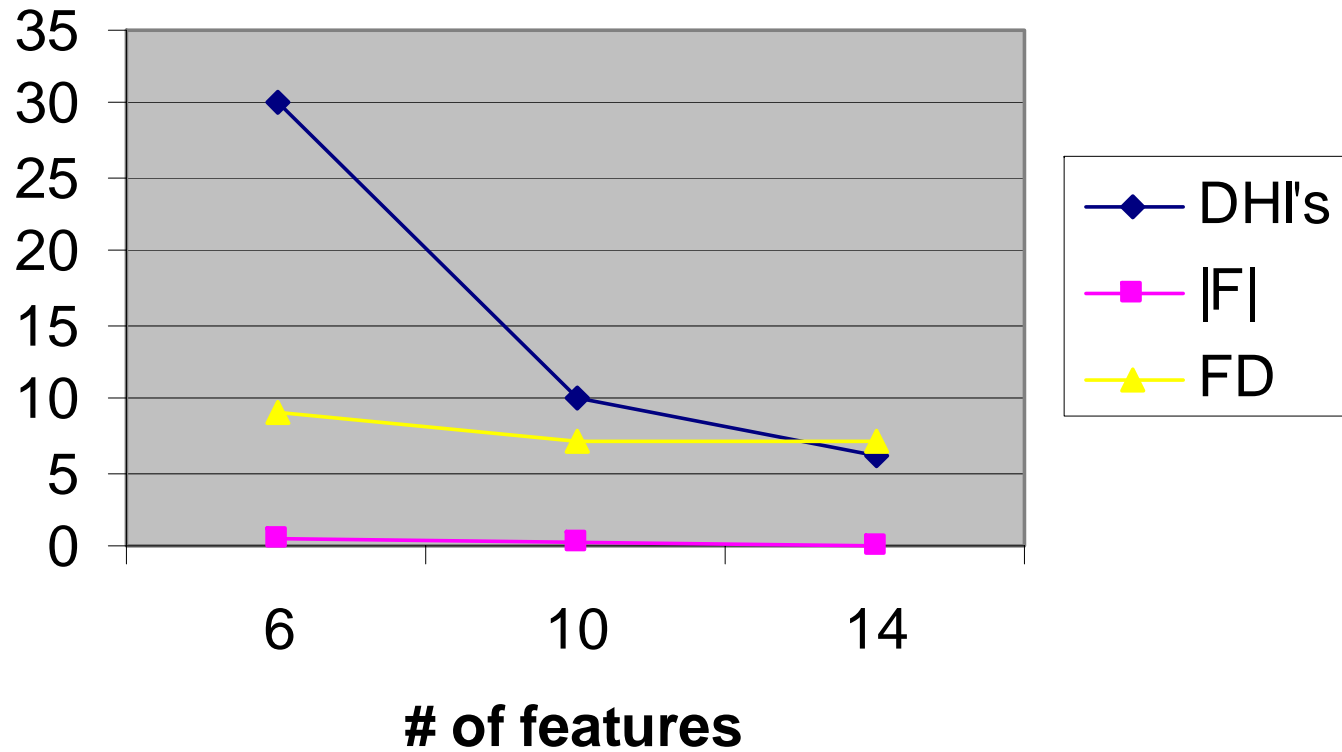

CI. Error for 10% Noise, Mahalanobis-CI.

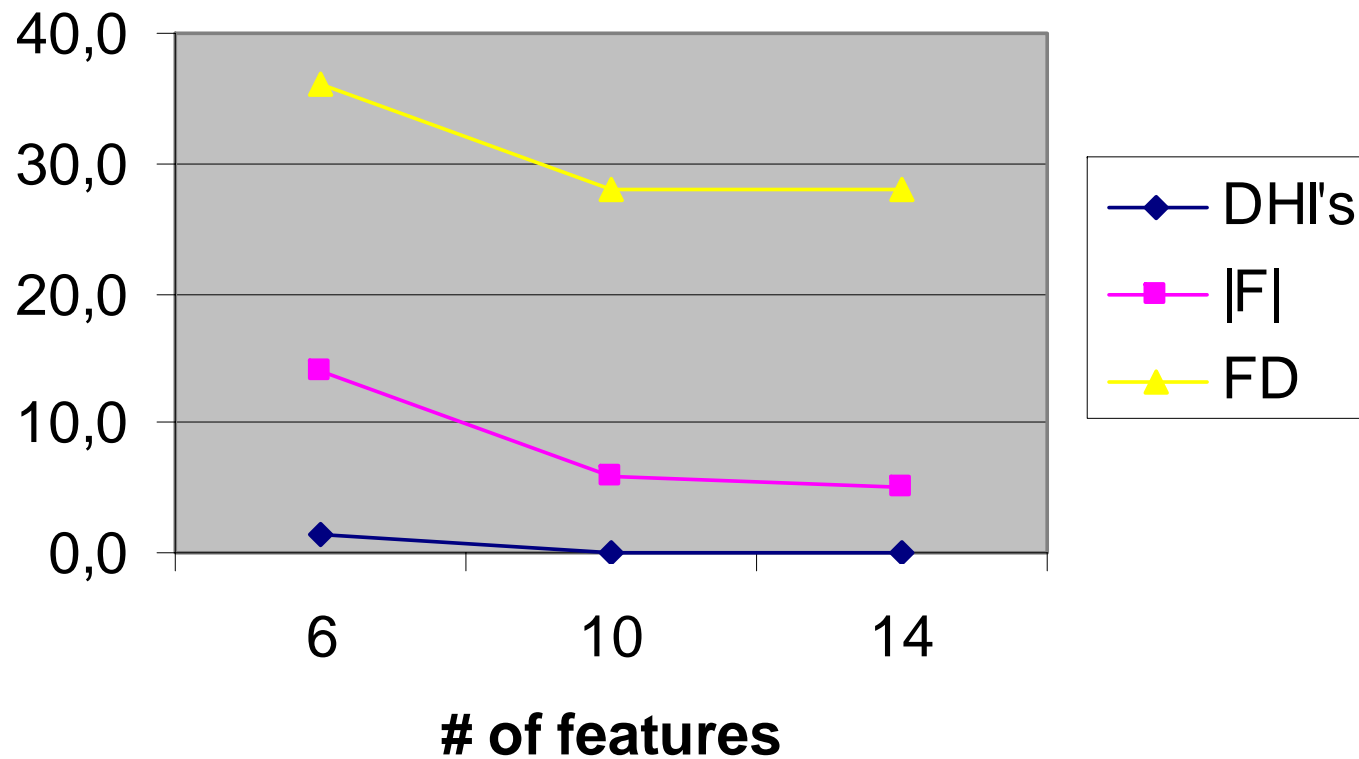

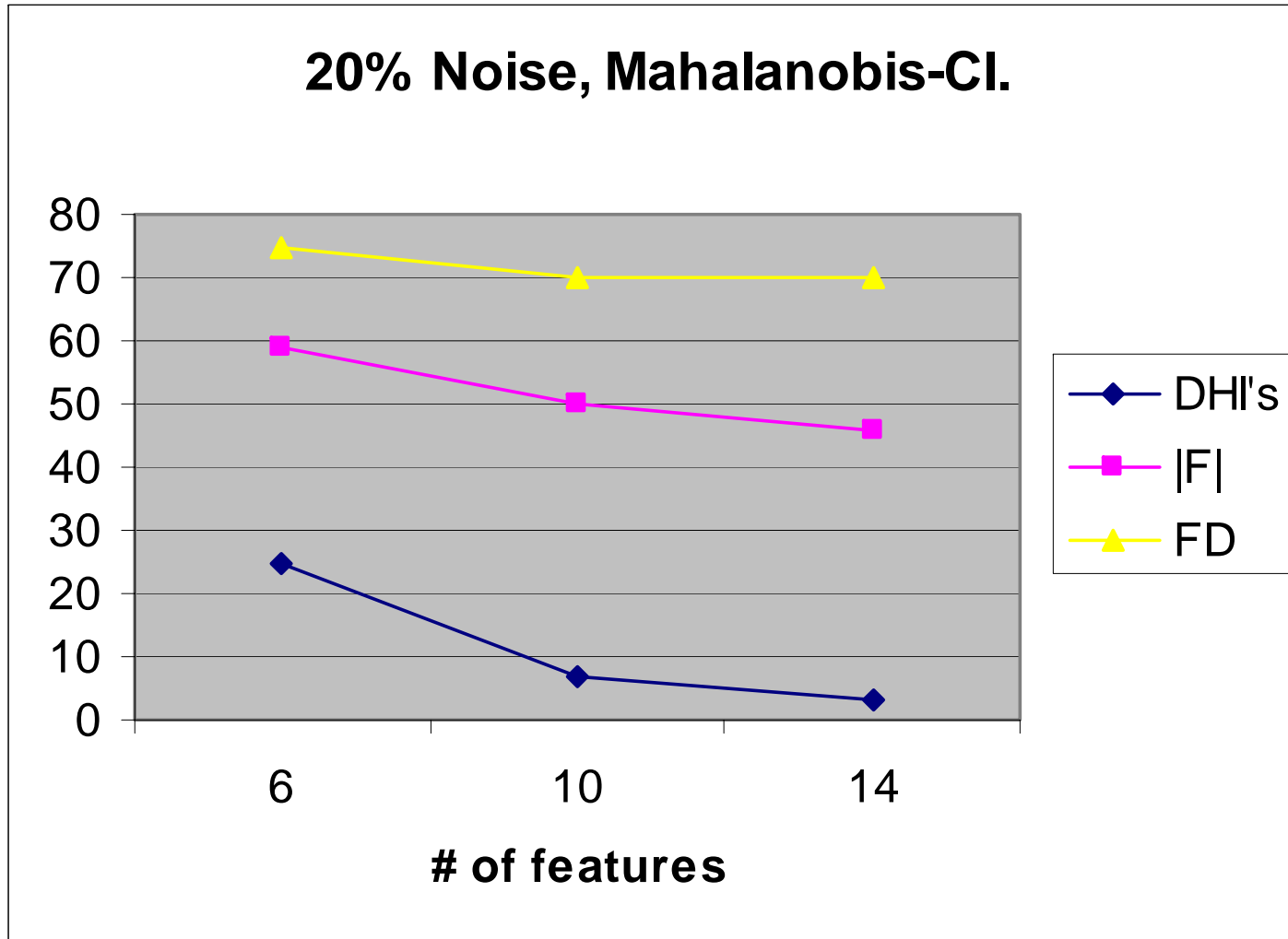

3D-Meshes

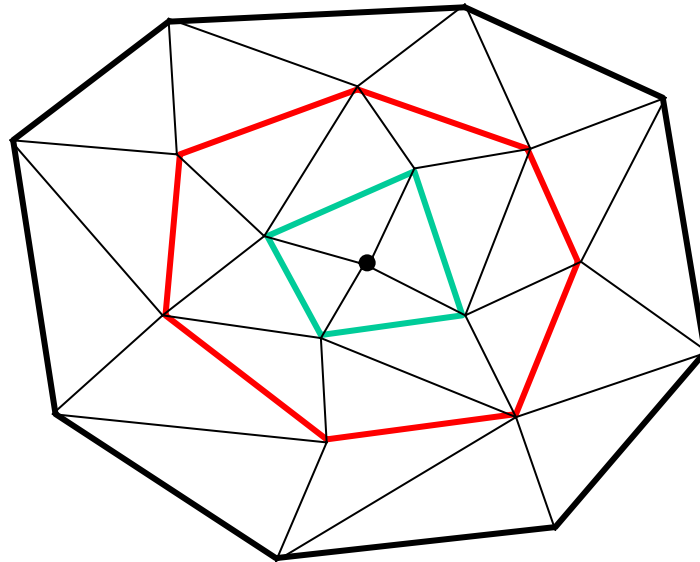

— neighbourhood of degree one

— neighbourhood of degree two

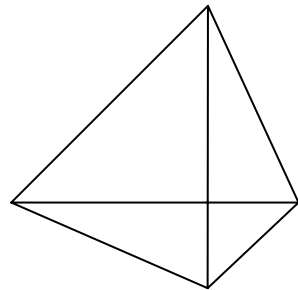

tetrahedron as the basic building block for a polyhedron

Topologically equivalent structures and (TE) non topologically equivalent structures (NTE)

TE

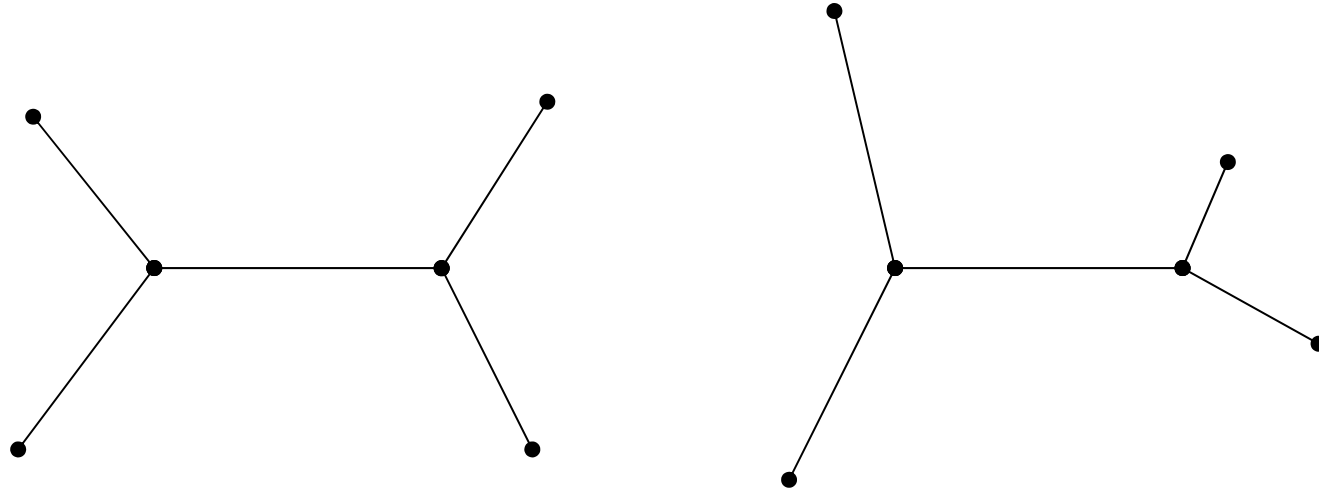

NTE

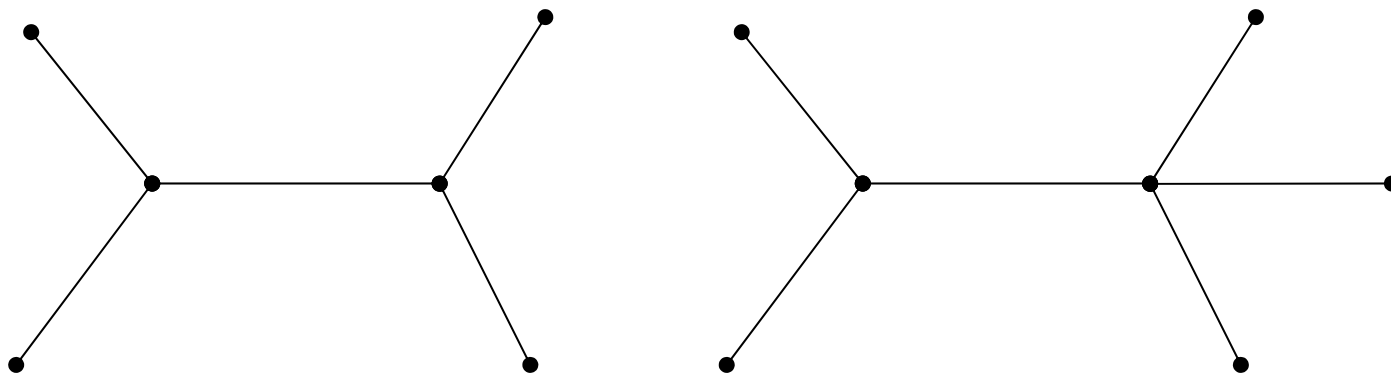

Properties

- If we constrain our calculation to a finite number of invariants we end up with a simple *linear complexity* in the number of vertices. This holds if the local neighborhood of vertices is resolved already by the given data structure; otherwise the cost for resolving local neighborhoods must be added.
- In contrast to *graph matching* algorithms we apply here algebraic techniques to solve the problem. This has the advantage that we can apply *hierarchical searches* for retrieval tasks, namely, to start only with one feature and hopefully eliminate already a large number of objects and then continue with an increasing number of features etc.

Conclusion

- In this paper we have introduced a novel set of invariants for discrete structures in 2D and 3D.
- The construction is a rigorous extension of Haar integrals over transformation groups to Dirac Delta Functions.
- The resulting invariants can easily be calculated with linear complexity in the number of vertices.
- The proposed approach has the potential to be extended to other discrete structures and even to the more general case of weighted graphs.

Literature: (<http://imb.informatik.uni-freiburg.de>)

- (1) S. Siggelkow and H. Burkhardt. Image retrieval based on local invariant features. In Proceedings of the IASTED International Conference on Signal and Image Processing (SIP) 1998, pages 369-373, Las Vegas, Nevada, USA, October 1998. IASTED.
- (2) M. Schael and H. Burkhardt. Automatic detection of errors on textures using invariant grey scale features and polynomial classifiers. In M. K. Pietikäinen, editor, Texture Analysis in Machine Vision, volume 40 of Machine Perception and Artificial Intelligence, pages 219-230. World Scientific, 2000.
- (3) O. Ronneberger, U. Heimann, E. Schultz, V. Dietze, H. Burkhardt and R. Gehrig. Automated pollen recognition using gray scale invariants on 3D volume image data. Second European Symposium on Aerobiology, Vienna/Austria, Sept. 5-9, 2000.
- (4) H. Burkhardt and S. Siggelkow. Invariant features in pattern recognition - fundamentals and applications. In C. Kotropoulos and I. Pitas, editors, Nonlinear Model-Based Image/Video Processing and Analysis, pages 269-307. John Wiley & Sons, 2001.